

Data Sheet



Article number: 021500700044

Description: Sealing Clamp S 44 W5

Measures

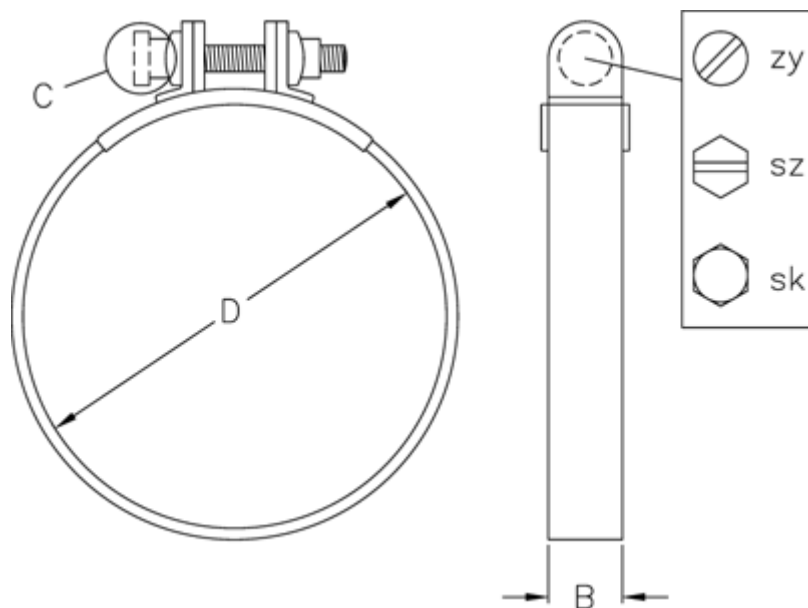

C (screw type) = SZ

Diameter D = 44

Width B = 20